

1

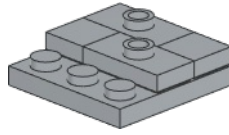

2

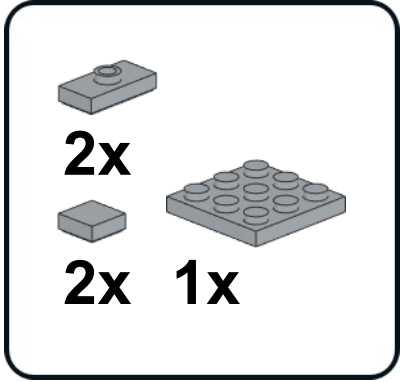
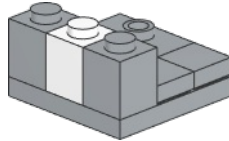
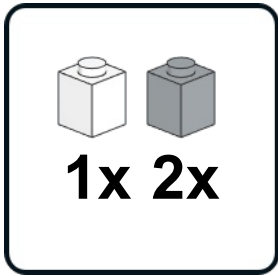

3

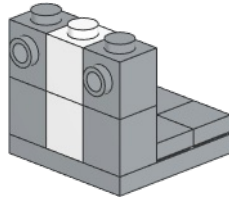
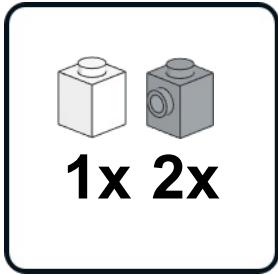

4

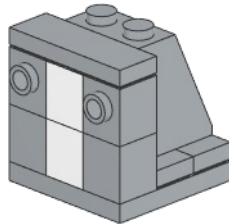
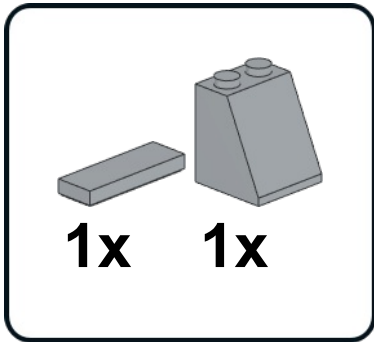

5

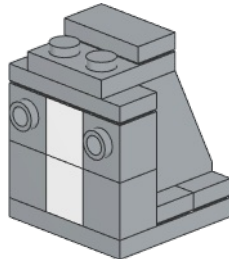
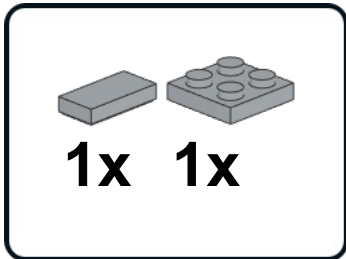

6

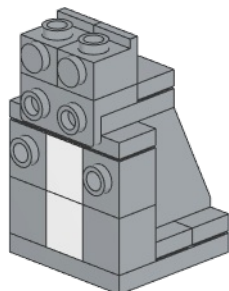
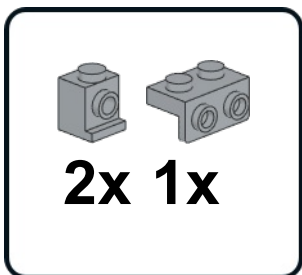

7

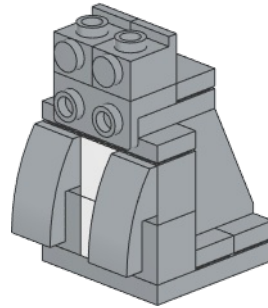
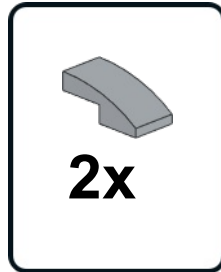

8

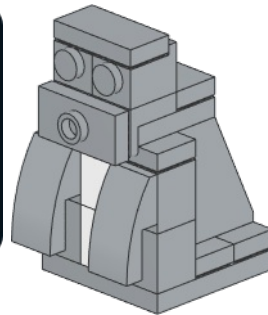
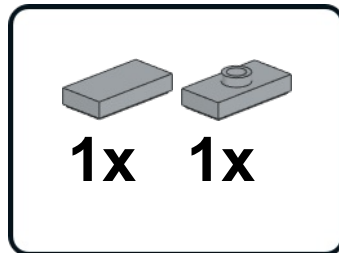

9

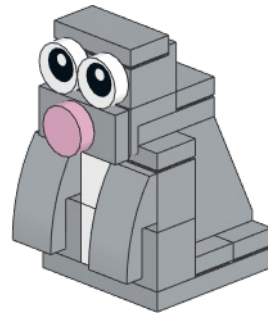
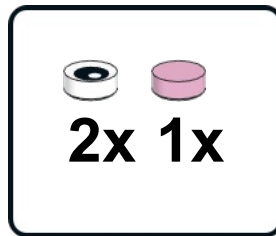

10

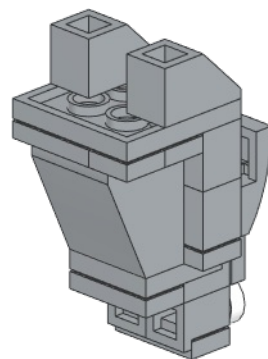
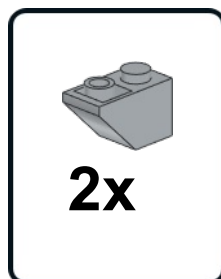

11

1x
1x 3x

1
2

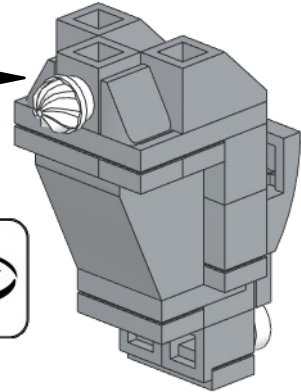

12

2x
2x
2x

1
2
x2

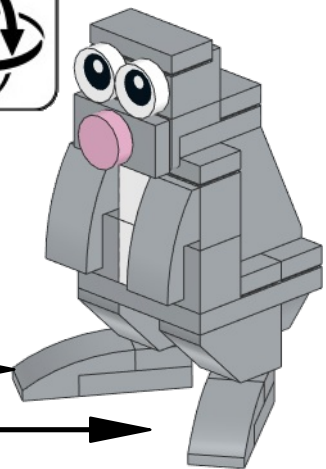

13

2x
2x
2x

1
2
x2

